

# Triacs sensitive gate

## BT139 series E

### GENERAL DESCRIPTION

Passivated, sensitive gate triacs in a plastic envelope, intended for use in general purpose bidirectional switching and phase control applications, where high sensitivity is required in all four quadrants.

### QUICK REFERENCE DATA

SYMBOL	PARAMETER	MAX.		UNIT
		600E	800E	
$V_{DRM}$	Repetitive peak off-state voltages	600	800	V
$I_{T(RMS)}$	RMS on-state current	16	16	A
$I_{TSM}$	Non-repetitive peak on-state current	140	140	A

### PINNING - TO220AB

PIN	DESCRIPTION
1	main terminal 1
2	main terminal 2
3	gate
tab	main terminal 2

### PIN CONFIGURATION

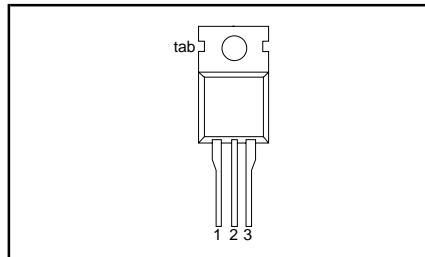

### SYMBOL

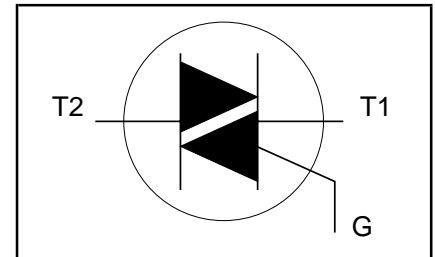

### LIMITING VALUES

Limiting values in accordance with the Absolute Maximum System (IEC 134).

SYMBOL	PARAMETER	CONDITIONS	MIN.	MAX.		UNIT
				-600 600 <sup>1</sup>	-800 800	
$V_{DRM}$	Repetitive peak off-state voltages		-	-600 600 <sup>1</sup>	-800 800	V
$I_{T(RMS)}$	RMS on-state current	full sine wave; $T_{mb} \leq 99\text{ }^\circ\text{C}$	-	16		A
$I_{TSM}$	Non-repetitive peak on-state current	full sine wave; $T_j = 25\text{ }^\circ\text{C}$ prior to surge $t = 20\text{ ms}$	-	140		A
		$t = 16.7\text{ ms}$	-	150		A
$I^2t$	$I^2t$ for fusing	$t = 10\text{ ms}$	-	98		A <sup>2</sup> s
$di_T/dt$	Repetitive rate of rise of on-state current after triggering	$I_{TM} = 20\text{ A}$ ; $I_G = 0.2\text{ A}$ ; $di_G/dt = 0.2\text{ A}/\mu\text{s}$	-	50		A/ $\mu\text{s}$
		T2+ G+	-	50		A/ $\mu\text{s}$
		T2+ G-	-	50		A/ $\mu\text{s}$
		T2- G-	-	50		A/ $\mu\text{s}$
		T2- G+	-	10		A/ $\mu\text{s}$
$I_{GM}$	Peak gate current		-	2		A
$V_{GM}$	Peak gate voltage		-	5		V
$P_{GM}$	Peak gate power		-	5		W
$P_{G(AV)}$	Average gate power	over any 20 ms period	-	0.5		W
$T_{stg}$	Storage temperature		-40	150		$^\circ\text{C}$
$T_j$	Operating junction temperature		-	125		$^\circ\text{C}$

<sup>1</sup> Although not recommended, off-state voltages up to 800V may be applied without damage, but the triac may switch to the on-state. The rate of rise of current should not exceed 15 A/ $\mu\text{s}$ .

Triacs  
sensitive gate

## BT139 series E

## THERMAL RESISTANCES

SYMBOL	PARAMETER	CONDITIONS	MIN.	TYP.	MAX.	UNIT
$R_{th\ j-mb}$	Thermal resistance junction to mounting base	full cycle	-	-	1.2	K/W
$R_{th\ j-a}$	Thermal resistance junction to ambient	half cycle in free air	-	60	1.7	K/W
			-		-	K/W

## STATIC CHARACTERISTICS

 $T_j = 25\text{ °C}$  unless otherwise stated

SYMBOL	PARAMETER	CONDITIONS	MIN.	TYP.	MAX.	UNIT
$I_{GT}$	Gate trigger current	$V_D = 12\text{ V}; I_T = 0.1\text{ A}$				
		T2+ G+	-	2.5	10	mA
		T2+ G-	-	4.0	10	mA
		T2- G-	-	5.0	10	mA
		T2- G+	-	11	25	mA
$I_L$	Latching current	$V_D = 12\text{ V}; I_{GT} = 0.1\text{ A}$				
		T2+ G+	-	3.2	30	mA
		T2+ G-	-	16	40	mA
		T2- G-	-	4.0	30	mA
		T2- G+	-	5.5	40	mA
$I_H$	Holding current	$V_D = 12\text{ V}; I_{GT} = 0.1\text{ A}$	-	4.0	30	mA
$V_T$	On-state voltage	$I_T = 20\text{ A}$	-	1.2	1.6	V
$V_{GT}$	Gate trigger voltage	$V_D = 12\text{ V}; I_T = 0.1\text{ A}$	-	0.7	1.5	V
$I_D$	Off-state leakage current	$V_D = 400\text{ V}; I_T = 0.1\text{ A}; T_j = 125\text{ °C}$	0.25	0.4	-	V
		$V_D = V_{DRM(max)}; T_j = 125\text{ °C}$	-	0.1	0.5	mA

## DYNAMIC CHARACTERISTICS

 $T_j = 25\text{ °C}$  unless otherwise stated

SYMBOL	PARAMETER	CONDITIONS	MIN.	TYP.	MAX.	UNIT
$dV_D/dt$	Critical rate of rise of off-state voltage	$V_{DM} = 67\% V_{DRM(max)}; T_j = 125\text{ °C};$ exponential waveform; gate open circuit	-	50	-	V/ $\mu$ s
$t_{gt}$	Gate controlled turn-on time	$I_{TM} = 20\text{ A}; V_D = V_{DRM(max)}; I_G = 0.1\text{ A};$ $dI_G/dt = 5\text{ A}/\mu$ s	-	2	-	$\mu$ s

Triacs  
sensitive gate

BT139 series E

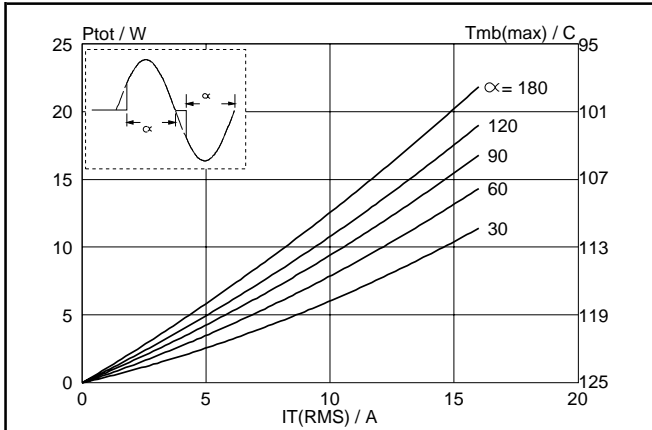

Fig. 1. Maximum on-state dissipation,  $P_{tot}$ , versus rms on-state current,  $I_{T(RMS)}$ , where  $\alpha$  = conduction angle.

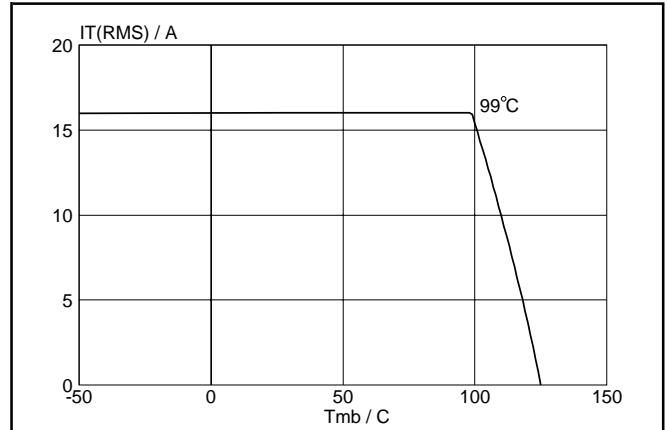

Fig. 4. Maximum permissible rms current  $I_{T(RMS)}$ , versus mounting base temperature  $T_{mb}$ .

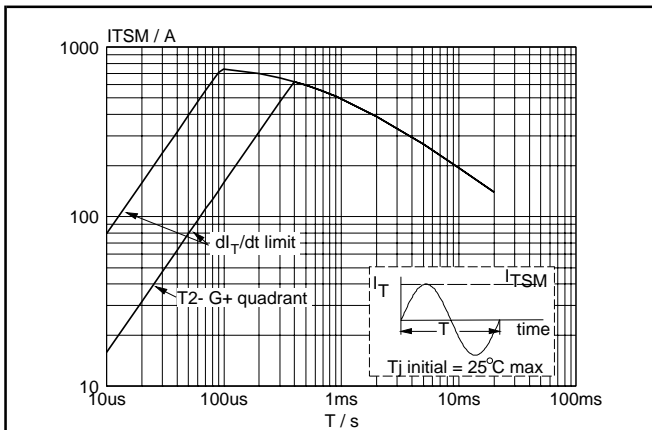

Fig. 2. Maximum permissible non-repetitive peak on-state current  $I_{TSM}$ , versus pulse width  $t_p$ , for sinusoidal currents,  $t_p \leq 20$ ms.

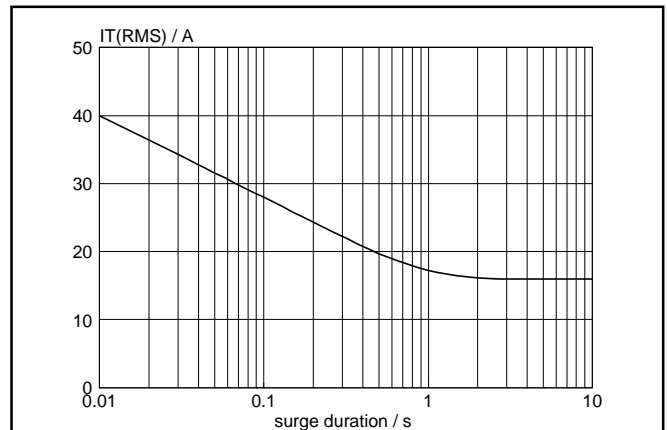

Fig. 5. Maximum permissible repetitive rms on-state current  $I_{T(RMS)}$ , versus surge duration, for sinusoidal currents,  $f = 50$  Hz;  $T_{mb} \leq 99^\circ\text{C}$ .

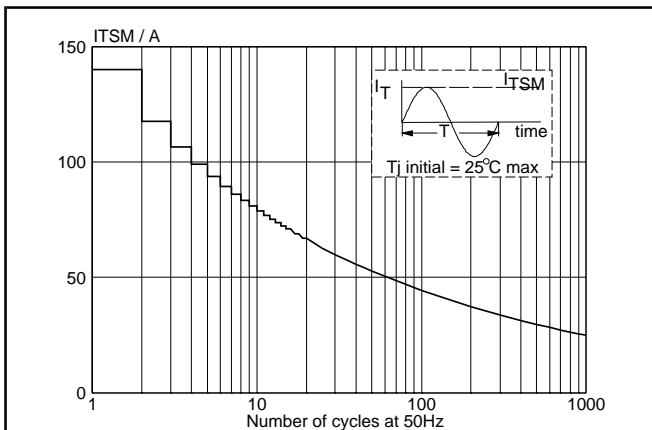

Fig. 3. Maximum permissible non-repetitive peak on-state current  $I_{TSM}$ , versus number of cycles, for sinusoidal currents,  $f = 50$  Hz.

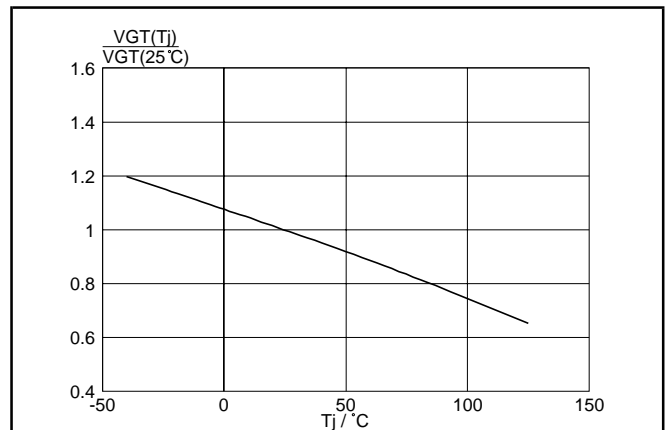
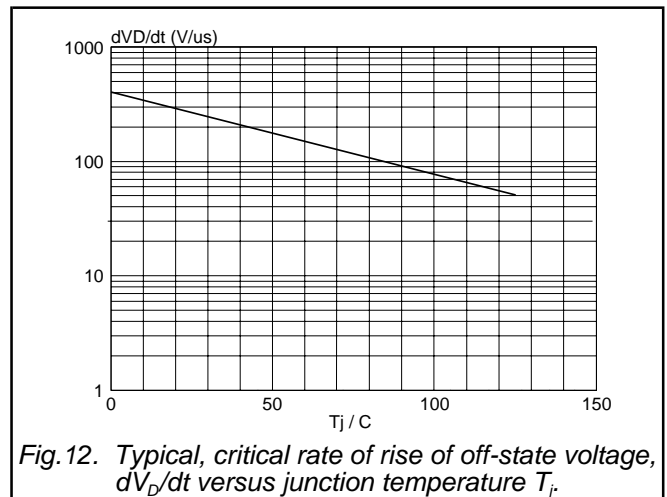
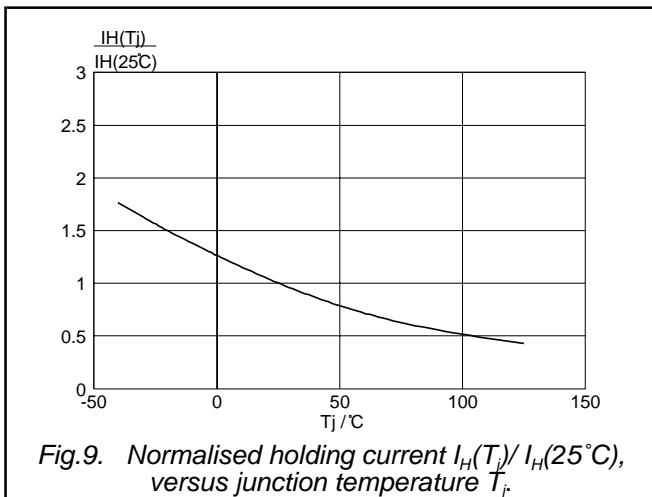
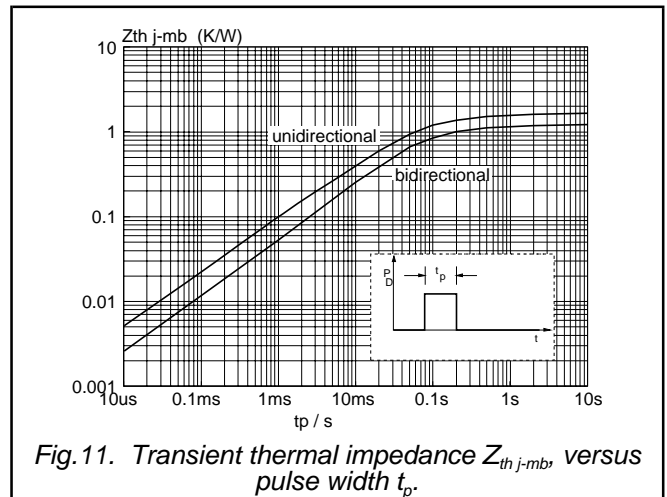
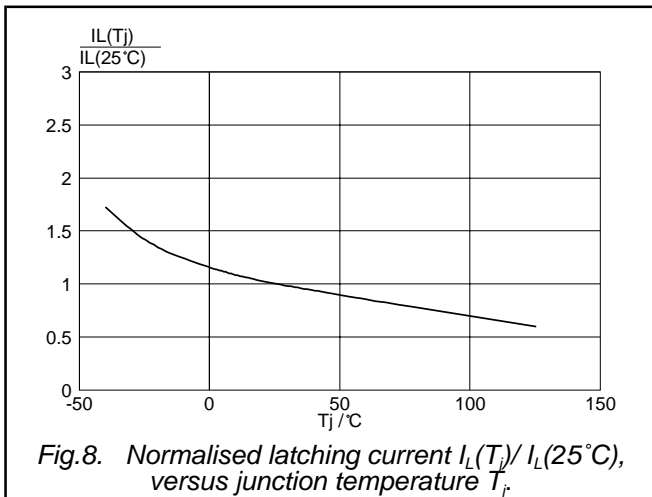
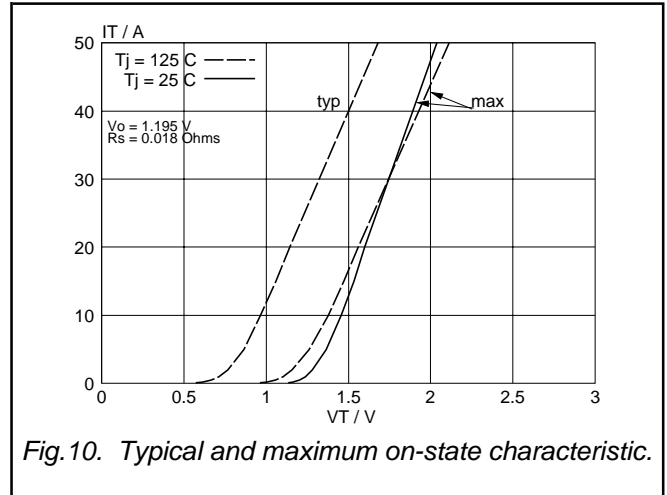
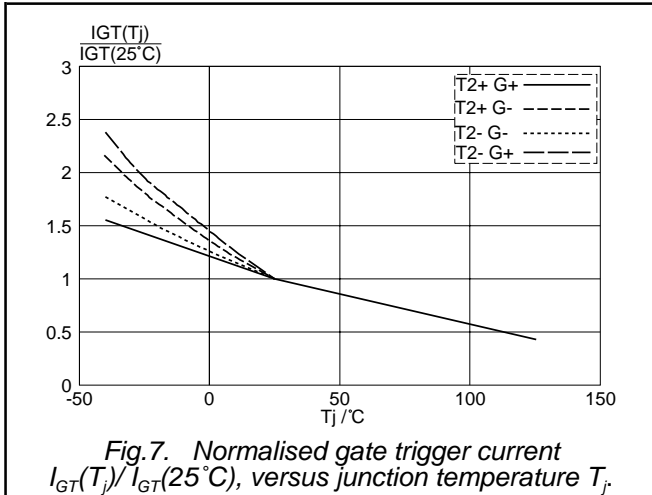

Fig. 6. Normalised gate trigger voltage  $V_{GT}(T_j) / V_{GT}(25^\circ\text{C})$ , versus junction temperature  $T_j$ .

Triacs  
sensitive gate

BT139 series E



Triacs  
sensitive gate

BT139 series E

**MECHANICAL DATA**

*Dimensions in mm*

*Net Mass: 2 g*

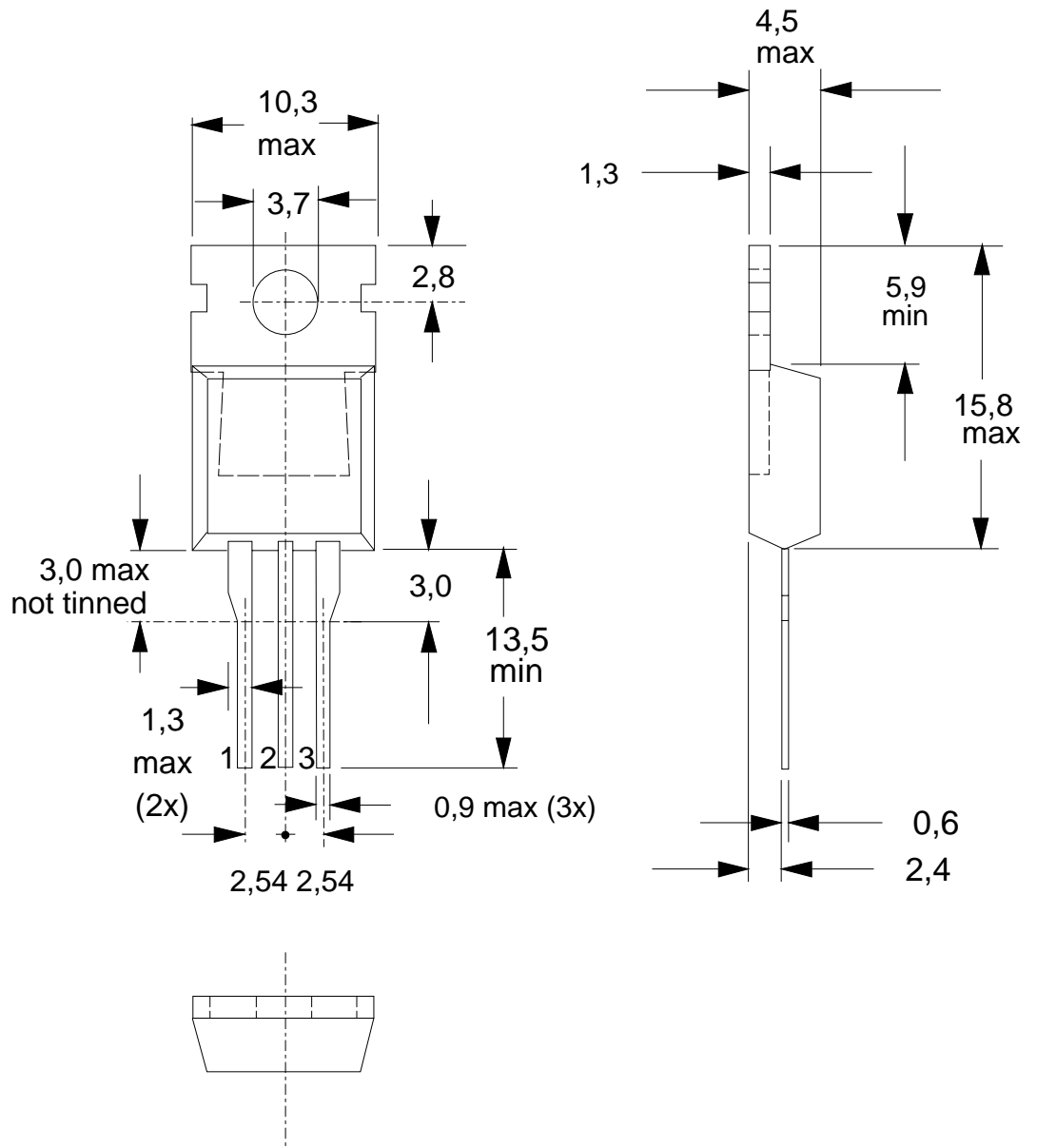

Fig. 13. SOT78 (TO220AB). pin 2 connected to mounting base.

**Notes**

1. Refer to mounting instructions for SOT78 (TO220) envelopes.
2. Epoxy meets UL94 V0 at 1/8".

Triacs  
sensitive gate

BT139 series E

**DEFINITIONS**

<b>DATA SHEET STATUS</b>		
<b>DATA SHEET STATUS<sup>2</sup></b>	<b>PRODUCT STATUS<sup>3</sup></b>	<b>DEFINITIONS</b>
Objective data	Development	This data sheet contains data from the objective specification for product development. Philips Semiconductors reserves the right to change the specification in any manner without notice
Preliminary data	Qualification	This data sheet contains data from the preliminary specification. Supplementary data will be published at a later date. Philips Semiconductors reserves the right to change the specification without notice, in order to improve the design and supply the best possible product
Product data	Production	This data sheet contains data from the product specification. Philips Semiconductors reserves the right to make changes at any time in order to improve the design, manufacturing and supply. Changes will be communicated according to the Customer Product/Process Change Notification (CPCN) procedure SNW-SQ-650A
<b>Limiting values</b>		
Limiting values are given in accordance with the Absolute Maximum Rating System (IEC 134). Stress above one or more of the limiting values may cause permanent damage to the device. These are stress ratings only and operation of the device at these or at any other conditions above those given in the Characteristics sections of this specification is not implied. Exposure to limiting values for extended periods may affect device reliability.		
<b>Application information</b>		
Where application information is given, it is advisory and does not form part of the specification.		
© Philips Electronics N.V. 2001		
All rights are reserved. Reproduction in whole or in part is prohibited without the prior written consent of the copyright owner.		
The information presented in this document does not form part of any quotation or contract, it is believed to be accurate and reliable and may be changed without notice. No liability will be accepted by the publisher for any consequence of its use. Publication thereof does not convey nor imply any license under patent or other industrial or intellectual property rights.		

**LIFE SUPPORT APPLICATIONS**

These products are not designed for use in life support appliances, devices or systems where malfunction of these products can be reasonably expected to result in personal injury. Philips customers using or selling these products for use in such applications do so at their own risk and agree to fully indemnify Philips for any damages resulting from such improper use or sale.

<sup>2</sup> Please consult the most recently issued datasheet before initiating or completing a design.

<sup>3</sup> The product status of the device(s) described in this datasheet may have changed since this datasheet was published. The latest information is available on the Internet at URL <http://www.semiconductors.philips.com>.